



URIMAT®

Swiss quality – since 1998.

EVERY DROP COUNTS

Welcome to URIMAT



Welcome to URIMAT

URIMAT is a leading manufacturer of environmentally friendly products in the sanitary ware industry.

In a place where others are passive, URIMAT is actively setting new trends and standards on a daily basis. The waterless urinals made by the Swiss manufacturer URIMAT are enjoying worldwide acceptance and simultaneously bringing hygiene and ecological protection to thousands of washrooms around the globe. As they discover the innovative technology and the high value retention of our products, new customers are placing their confidence in our solution every day, thereby actively helping to save millions of litres of clean drinking water. In regions where this valuable resource is in short supply, such arguments are becoming even more crucial in an era of climate change.

As a market leader, URIMAT is fully committed to ecological sustainability. Our products are manufactured using eco-friendly materials and production processes. When choosing our partners we emphasise carbon-neutral production and high ethical standards.

Our uncompromising quality control and leading technology guarantee durable products with odourless, hygienic and ecological operation.

Make a statement today.
Choose URIMAT.





Used worldwide

You're in good company
with URIMAT

When you choose to rely on the technology of the market leader – the waterless urinals by URIMAT – you are in excellent company.

Take McDonald's, for example – A global corporation that subscribes to high ecological principles and is committed to sustainability. By installing URIMAT in their premises worldwide, McDonald's is sending a clear message and saving billions of litres of valuable drinking water.

In virtually every industry, we can name prestigious references that place their confidence in us every day. Make a statement now! Choose URIMAT!

URIMAT

The ecological environmental system.



1 High-tech plastic bowl, carbon-neutral manufacturing, 100% recyclable

2 Unique odour trap technology with integrated cleaning system Saving minimum 100,000 litres of drinking water a year per urinal = 17.5 kg less CO₂

3 Microbiological cleaning system

4 Financing possibility through advertising



URIMAT sets standards

As a leading company for waterless sanitary technology, URIMAT is continually redefining the quality standard. Our constant striving for new solutions to protect that precious resource, water, have been endorsed over recent years by numerous renowned international environmental awards and certifications.



URIMAT Water is life*.

URIMAT is a leading producer of environmentally friendly products in the sanitary ware industry



* Around 71% of the earth's surface is covered by water. But only 0.3% of all the water on the planet is available in streams, rivers and groundwater for potential use as drinking water.

The original.

The waterless urinals from the market leader at a glance!



Model	URIMAT eco	URIMAT ecoplus	URIMAT ecovideo
Article code	15001	16001	16981
Colour	● white	● white	● white
Weight	4,2 kg	4,4 kg	5,5 kg
Special feature		passive advertising display	with LCD video display
Technology			WiFi and USB
NRV Technology (Non-Return-Valve)	x	x	x

Model ranges eco and compact

Innovative and functionally designed urinals made from durable high-tech plastic. No water, no chemicals, no odours. The patented mechanical drain trap and microbiological cleaning agents guarantee trouble-free, odourless operation.

Dimensions (in mm)

eco

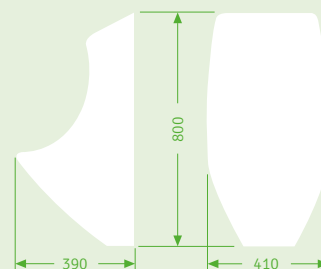

compact

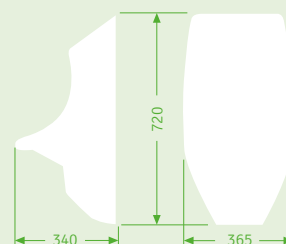



URIMAT
compactplus

URIMAT
compactvideo

URIMAT
ceramic20

URIMAT
ceramicC2

URIMAT
ceramicC2-CS

14001

14981

12220

12401

12402

● white

● white

● white

● white

● white

3,5 kg

4,5 kg

21 kg

17 kg

19 kg

passive
advertising display

with LCD video
display

WiFi and USB

x

x

✓

✓

✓

Model range ceramic

Elegance meets technology. The complete absence of a flushing rim and sharp edges in the vitreous china urinals from URIMAT actively avoid any build-up of deposits. The non-porous glaze of the URIMAT ceramic bowl ensures that no residues are left. No water, no chemicals, no odour. The patented mechanical drain trap and the microbiological cleaning agents guarantee trouble-free, odourless operation.

Dimensions (in mm)

ceramic20

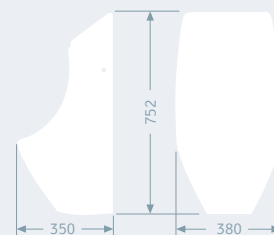

ceramicC2

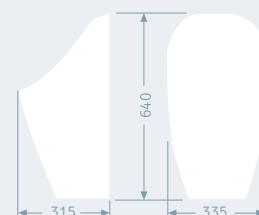

URIMAT-CS

The latest innovation in waterless cleaning technology from URIMAT

- ✓ **Easy to maintain**
Time and cost-saving maintenance
- ✓ **Ecological and sustainable**
Resource-conserving, waterless cleaning system
- ✓ **Maximum hygiene**
Regular cleaning intervals
- ✓ **Fully automated**
Programmable cleaning intervals
- ✓ **Easy to install**
Rapid installation with straightforward assembly system
- ✓ **Little cleaning required**
Measureable cleaning work
- ✓ **Alternating LED display**
Displays functional status and cleaning agent level
- ✓ **Protects drain pipes**
MB-ActiveCleaner-CS minimises deposits in the drain pipe
- ✓ **Maximum operating safety**
With patented URIMAT MB-Active technology



How it works

Guaranteed cleanliness: Simple and safe



Art. no. 52411

1 MB-ActiveTrap-CS

Easy to install in just one motion

With just a little pressure, the MB-ActiveTrap-CS can be placed in the urinal drain opening.

2 Screw in MB-ActiveCleaner-CS

A quick turn of the hand and the MB-ActiveCleaner-CS bottle sits tightly in the holder.



Art. no. 80.016



3 The URIMAT cleaning system ready to use in no time

The LED display flashes green and signals that the system is ready for operation. The programmable cleaning intervals start automatically. From now on, the amount of cleaning required decreases significantly and both hygiene and safety increase.

LED display

- 1 MB-ActiveTrap-CS turns green:**
The system is ready for operation
- 2 MB-ActiveTrap-CS turns red:**
The MB-ActiveCleaner-CS bottle is empty and has to be replaced.

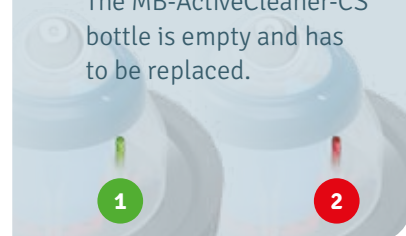

NRV 2.0

Hygienic service,
without any
compromise!

Non-Return Valve from URIMAT.

The patented Non-Return Valve prevents drain odours from escaping when the MB-ActiveTrap is removed.

The integrated valve closes automatically when the MB-ActiveTrap is removed, keeping washrooms and facilities free of drain odours even during maintenance work.

This ensures a noticeable improvement in terms of maintenance intervals.

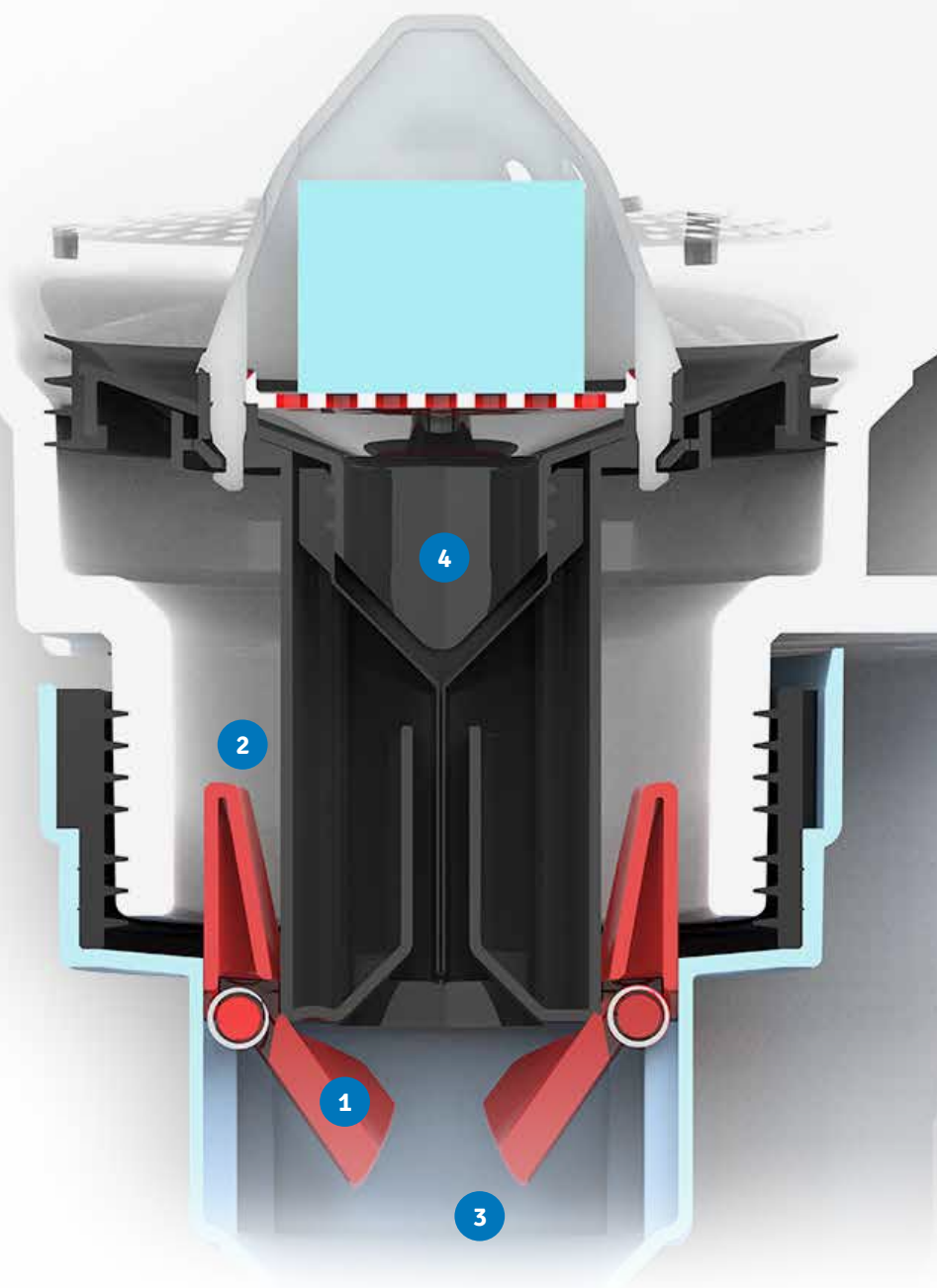

Non-Return Valve from URIMAT

- 1 The integrated valve closes automatically when the MB-ActiveTrap is removed.
- 2 A guidance bar ensures a proper and easy fit.
- 3 Waste pipe is closed and keeps washrooms and facilities free of drain odours even during maintenance work.
- 4 The valve opens when the MB-ActiveTrap is inserted.

MB-ActiveTrap

Sophisticated technology for the most basic of needs.

The URIMAT MB-ActiveTrap collects the urine and channels it into the waste pipe without flushing, while at the same time sealing in any odours. Fluids are channelled via a vertical membrane straight into the sewage system. Above the membrane there is a microbiological cleaning block which prevents build-up of deposits both inside the odour seal unit and in the waste pipe. As soon as fluids stop flowing through the membrane, it automatically forms an air-tight seal.

After the MB-ActiveCube has dissolved, the red surface beneath the transparent cover signals that the odour trap has to be replaced.



The patent for 100% odour-free function

1 Patented three-way control

The cover of the integrated MB-ActiveCube has three settings which regulate the efficiency of the block, thereby controlling its effective service life.

2 Integrated MB-ActiveCube

The integrated MB-ActiveCube improves hygiene, reduces deposits and prevents the inside of the odour trap and the waste pipe becoming encrusted with organic matter, urine deposits and fats.

3 Lifecycle indicator

When the MB-ActiveTrap needs to be changed, the life-cycle indicator will let you know. After the MB-ActiveCube has been removed, the red surface below the transparent cover indicates that the MB-ActiveTrap needs to be replaced.

4 Vertically sealing membrane system

The vertical membrane technology guarantees that odours are completely sealed away and is able to withstand both negative and positive pressures. It is impossible for gases from the sewage system to escape.

New MB-ActiveTrap with new MB-ActiveCube



MB-ActiveCube after about 50% usage



MB-ActiveCube is nearly at end of life-cycle. MB-ActiveTrap needs to be replaced soon



MB-ActiveCleaner

PH-neutral, biological and sustainable.

Dermatologically tested for skin-friendliness and found to be «very good». MB-ActiveCleaner eliminates the bad odours caused when organic matter decomposes. It is particularly well suited for maintenance cleaning and odour elimination in heavily used washrooms & sanitary facilities.

MB-ActiveCleaner contains micro-organisms that penetrate the pores (joints) and destroy any odours caused by organic residues deposited there, leaving a pleasant and lasting freshness. Used daily, it prevents odours from developing.

By delaying resoiling, MB-ActiveCleaner makes an active contribution to maintaining cleanliness in all environments.

ph-neutral
biological
grease stain remover
no harmful vapors
eco-friendly



Areas of application

- › Toilets and sanitary facilities
- › Washrooms and showers
- › Facades, passages and stairways
- › Waste containers and refuse collection stations
- › Floors, carpets etc.

URIMAT sets standards



How it works

Securing an odour free bathroom experience.



1 What are spores?

The word spore refers to the developmental stage of a living being, which serves to reproduce, spread, survive or serve several of these purposes at the same time.

Spore (endospores) are also formed by bacteria. They are very resilient and can adjust their entire metabolism, i.e. they do not need oxygen, water or nutrients.

Under certain environmental conditions, these endospores can develop back into active developmental stages of the bacteria.

2 How do the spores develop usable bacteria?

By creating an optimal environment for the different spores, i.e. providing nutrients in combination with oxygen and water, the bacteria are reactivated.

Now the MB-ActiveCleaner becomes active.



3 Why is the formation of odours prevented by the use of bacterial spores?

Unpleasant odours are caused by the decomposition of organic materials (urine, fats, etc., ...). These materials serve as food for the bacteria used and are thus eliminated before unpleasant odours develop. The bacterial spores have a preventive effect.

MB-ActiveCleaner is not only a very effective but also an environmental solution to maintain your facility.

Urinal partition walls by URIMAT!

Partition wall and design element in one

URIMAT uses elegantly shaped urinal partition walls made of Trespa®, toughened safety glass and stainless steel. These durable and decorative dividers are largely resistant to all common household solvents and chemicals; due to this the materials have been used for many years in applications where cleanliness and hygiene are indispensable. They do not need any special care, just cleaning.

URIMAT urinal partition walls are a perfect design element in your wash-room.

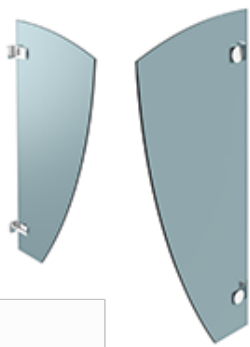

Safety Glass

The URIMAT urinal partition ESG is made from high quality toughened, nano-repellent, translucent/frosted, safety glass with a thickness of 8mm and a length of 1 metre.



Trespa®

URIMAT Trespa® partition walls are made of high-quality, recyclable, compressed wood and paper fibres, which ensure absolute stability and sufficient privacy protection in your sanitary room.



Inox

The URIMAT inox urinal partition is made from a polycarbonate core and is covered by stainless steel. Combining both materials makes the wall partition vandalism proof while keeping its elegant design and reducing the product weight to a minimum.

Mounting frames

The practical mounting element for new installation and renovation

URIMAT mounting frames ensure the accurate fit and simple assembly using just four fixing screws.

URIMAT KeraFix is highly recommended in dry construction and when installing ceramic urinals.

The four mounting brackets ensure highly secure installation and enable precise horizontal and vertical alignment.

When installing our high tech plastic urinals URIMAT MakroFix is the perfect solution.

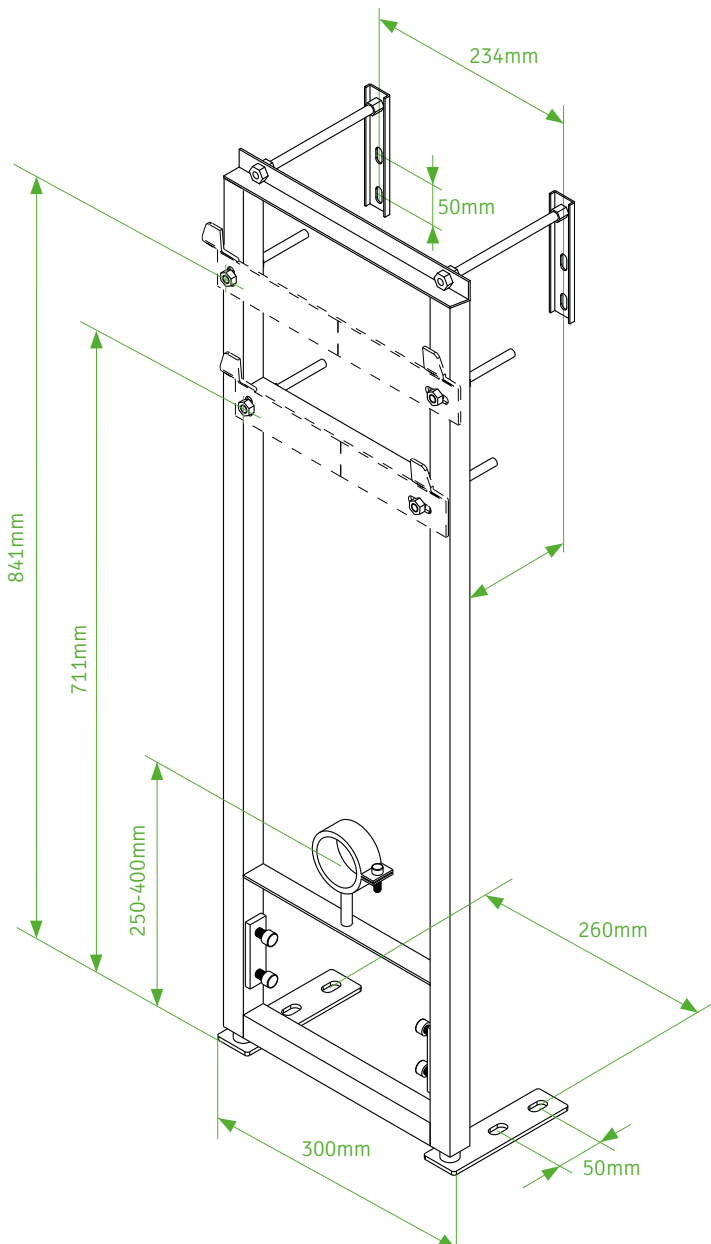

Advertising with URIMAT connect

A high-yield investment.

URIMAT is not only a market leader among waterless urinals, but at the same time offers an advertising medium with significant reach in a clearly defined target group. There is no changing the channel or turning the page. Your advertising message is viewed on average for 40 seconds.

Depending on the model, the urinals from URIMAT offer either static advertising displays or high-resolution LCD-screens with animated messages that hit home within your target group.

A modern and audience-specific medium that allows you or your customers to address your target group in the most effective way. The URIMAT media partners will be pleased to advise you.

The Acceptance Study

- › captive audience of 40 seconds
- › no divergence loss

The Acceptance Study was performed in Switzerland by the renowned market research institute, IHA-GfK.

93%

of all those surveyed said the advertising screen was the first thing they noticed on the URIMAT!

96%

find the advertising on the URIMAT positive or aren't bothered by it!

90%

remember the message on the URIMAT advertising display!



Ultimately only hard facts count!

Arguments that have persuaded even URIMAT's most demanding customers:

✓ Annual savings of at least 100,000 litres of drinking water per urinal per year

✓ No Water consumption

✓ No urine scale build-up

✓ No chemicals

✓ CO₂ reduction (at least 175g per m³ water)

✓ No flushing systems necessary

✓ CO₂-neutral manufacturing

✓ Worldwide patented system and design

✓ Microbiological cleaning system

✓ Advertising Income possible

✓ Durable materials

✓ All-round service with our own staff

✓ Successful since 1998

✓ Swiss quality

✓ Leasing options available

✓ Gain points for LEED & BREEAM accreditation

100,000

Annual savings of at least 100,000 litres of drinking water per urinal per year

90%

Remember the message on the URIMAT advertising display!

175g

CO₂ reduction (at least 175g per m³ water)

References selection

Why do customers choose URIMAT?

URIMAT waterless urinals are widely in use by many different industries. URIMAT cooperates with international brands such as McDonald's, Nestlé, Nespresso, Migros, Coop, Pathé, Kitag or Toyota.

Our customers value the positive environmental impact and great water savings. For some, total freshwater consumption is reduced by up to 10%.

Many industries are confronted with questions about their sustainability. URIMAT helps to overcome those requirements by lowering the freshwater consumption and reducing the CO₂ footprint, while at the same time communicating those measurements towards an audience through the integrated display.

URIMAT is known for products offering the highest available resistance against physical force, low installation and maintenance cost and just fewer problems for the janitor in your building.

Less technical and operational problems, reduced maintenance time, high water savings, a fast cleaning procedure, communication and premium customer support are key values that URIMAT owners know to value.



Square One (CA)



Stadium Tottenham Hotspur (UK)



McDonald's (UK)



AFAS Live (NL)



SBB Schweizerische Bundesbahnen (CH)



KITAG (CH)



Grandvalira (ES)



Stadium St. Jakob Park (CH)



Stadion Stožice (SLO)



Marché (CH)



Railway station Winterthur (CH)



Jyväskylässä (FIN)



URIMAT®

Swiss quality – since 1998.



URIMAT Schweiz AG

Etzelstrasse 39
8634 Hombrechtikon
Switzerland

☎ +41 (0)55 251 52 30

🌐 www.urimat.ch